



**spiegels®**

first class  
office manufacturing

**Chefzimmer  
Executive Offices**



# Neue Sichtweisen

## New points of view



### Einleitung

Neue Technologien, neue Arbeitsweisen und letztendlich neue Geisteshaltungen haben in den vergangenen Jahren nicht nur die Unternehmen sondern auch ihre Chefszimmer verändert. Die Räume sind smarter geworden. Sie sind Abbilder der Firmenkultur und wie gemacht für Entscheidungen und Handlungen mit Tragweite. Wir bei spiegels verleihen diesen Räumen mit entsprechender Ausstattung eine Atmosphäre der Wertschätzung und agieren dafür in modernen wie traditionellen Umfeldern mit bewährter Stilsicherheit. Repräsentative Optik, flexible Nutzungsmöglichkeiten und das richtige Gefühl im Raum transportieren Haltung und lassen gleichzeitig viel Spielraum für Individualität. Das ist First Class Office Manufacturing.

**Geschäftsführung, CEO**  
**Monika Lax,**  
**Karl-Heinz Spiegels**

### Introduction

New technologies, new ways of working and ultimately new attitudes have not only changed the company but also its executive's offices in recent years. The rooms have become smarter. They are images of corporate culture and are made for decisions and actions with scope. We at spiegels impart these rooms with facilities suitable to an atmosphere of appreciation and operate them in modern and traditional environments with a good sense of style. A representative appearance, flexibility of use and the right feeling in the room creates a really easy attitude and lets at the same a lot of room for individuality. This is First Class Office Manufacturing.

6

**.sun**



18

**.taros**



18

**.taros xl**





- 66 **Furnier** | Veneer
- 68 **Manufaktur** | Manufacture
- 71 **Zertifikate** | Certificates



# .sun

Angetrieben von einem fixen Punkt formen sich neue Körper zueinander. Materie wie Glas, Metall und Holz lässt ungeahnte Kombinationen entstehen. Sie sind Teil eines ganzen Systems, definiert durch eine Quelle – ein Ursprung für Licht, Wärme und Leben in der Unendlichkeit von Raum und Zeit.

Die vielfältigen Möglichkeiten machen aus dieser besonderen Design-Idee ein ganzes System mit vielen Vorteilen. Der Tisch verfügt über diverse Modifikationen. Verbindendes Glied ist die elegante, verchromte Stahlkonstruktion, die bei einer verglasten Tischplatte auch von oben zum Ausdruck kommt. Möglich sind Schreibtische mit und ohne Sideboard, sowie kleine Konferenzlösungen. Durch die aufstrebenden, schlanken Fußelemente entsteht der schwebende Charakter von sun.

**Erforschen Sie ein Tischsystem mit  
grazilem Charme, filigraner Leichtigkeit  
und hoher Strahlkraft.**

Powered by a fixed point, new body shapes come to each other. Matter such as glass, metal and wood create unexpected combinations. They are part of a whole system, defined by a source – a source of light, warmth and life in the infinity of space and time.

Due to the numerous possibilities, this particular design idea creates a whole system with many advantages. The table has several modifications. The connecting link is the elegant, chrome-plated steel structure, which also comes from the top with a glazed tabletop to expression. Desks are available with and without sideboard, and small conference solutions. The emerging, slender foot elements create the floating nature of sun.

**Explore a table system with gracious charm,  
filigree lightness and high brilliance.**











Die Tischplatte bietet vor allem mit dem Material Holz viele integrierte Optionen wie zum Beispiel die ausziehbare Ledereinlage. Durch leichtes Schieben eröffnet die Tischplatte Stauraum für Technik und Schreibutensilien. Zwei dezente Aussparungen bieten genügend Raum für Kabelaustritte.

The tabletop offers, especially with the wood material, many integrated options such as the pull-out leather insert. By gently pushing the tabletop, space opens for media and writing utensils. Two discreet openings provide sufficient room for cable outlets.



Code scannen und mehr über die Funktion der Schiebeplatten erfahren.

Scan the code and learn more about the function of the sliding plates.

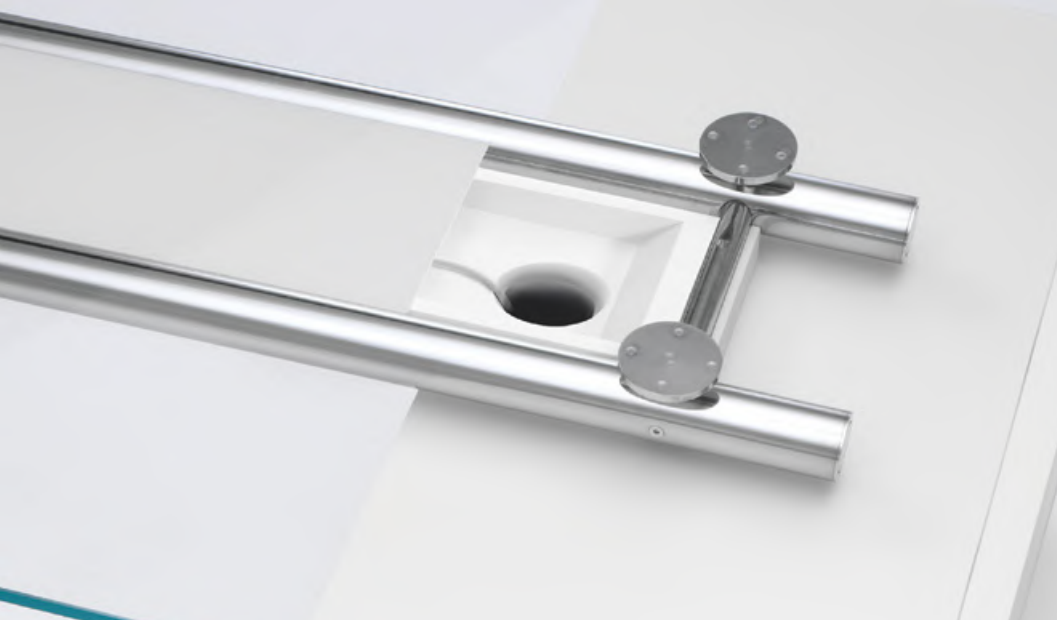

Kabelkanal mit Abdeckung zwischen den Träger-Rohren  
Cable duct with cover between the carrier tubes



Schlankes Fußelement  
Slim foot elements



Integrierte Technik unter der Drehklappe  
Integrated multimedia below the rotary door

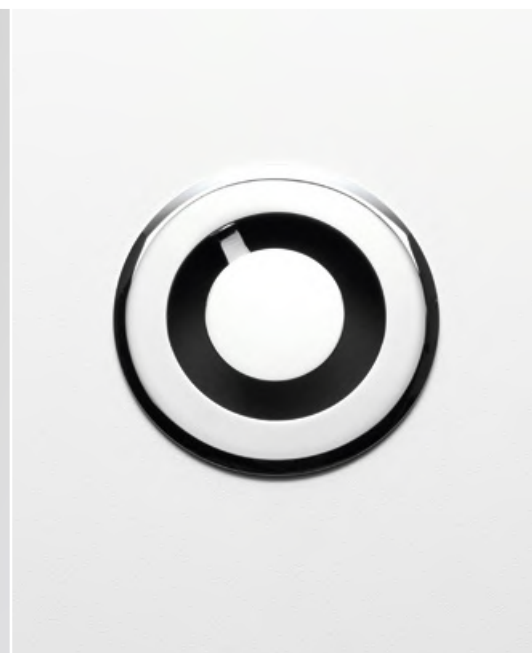

Kabelaustritt bei geschlossener Klappe  
Cable outlet with the flip closed



Kabelaustritt rückseitig unter der Drehklappe  
Cable outlet at the rear of the rotary door

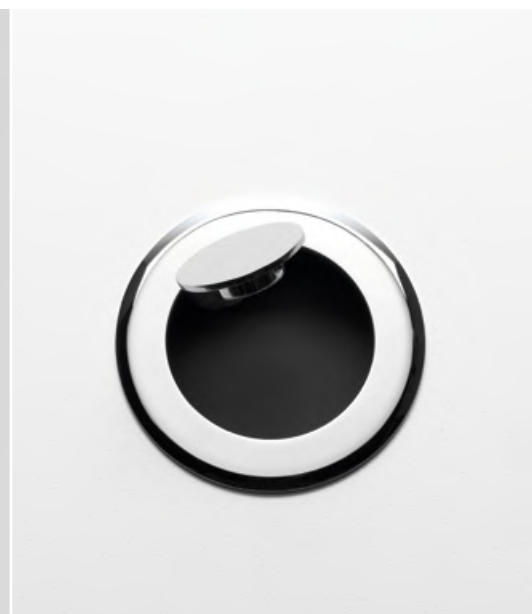

Kabelaustritt bei geöffneter Klappe  
Cable outlet with the flip open



Die Materialien Glas, Chrom und Strukturlack lassen dieses Modell in besonderer Harmonie erstrahlen. Alle Details passen sich in das leichte Ambiente ein. Edle Optik und angenehme Haptik sind die Merkmale dieser Oberflächen.

The glass, chrome and textured finish make this model shine in a special harmony. All details fit into the light atmosphere. Elegant appearance and pleasant feel are the characteristics of these surfaces.





Filigrane Plattenkanten 8 mm, Ecken gerundet  
Intricate tile edges 8 mm, corners rounded



Aufgeklipste Kabelführung  
Opened cable management



Ausziehbare Ledereinlage mit Anschlussfeld und Materialmulde  
Extendable leather insert with terminal box and material well



Kabelschlitze bei eingeschobener Platte  
Cable slots with closed plate

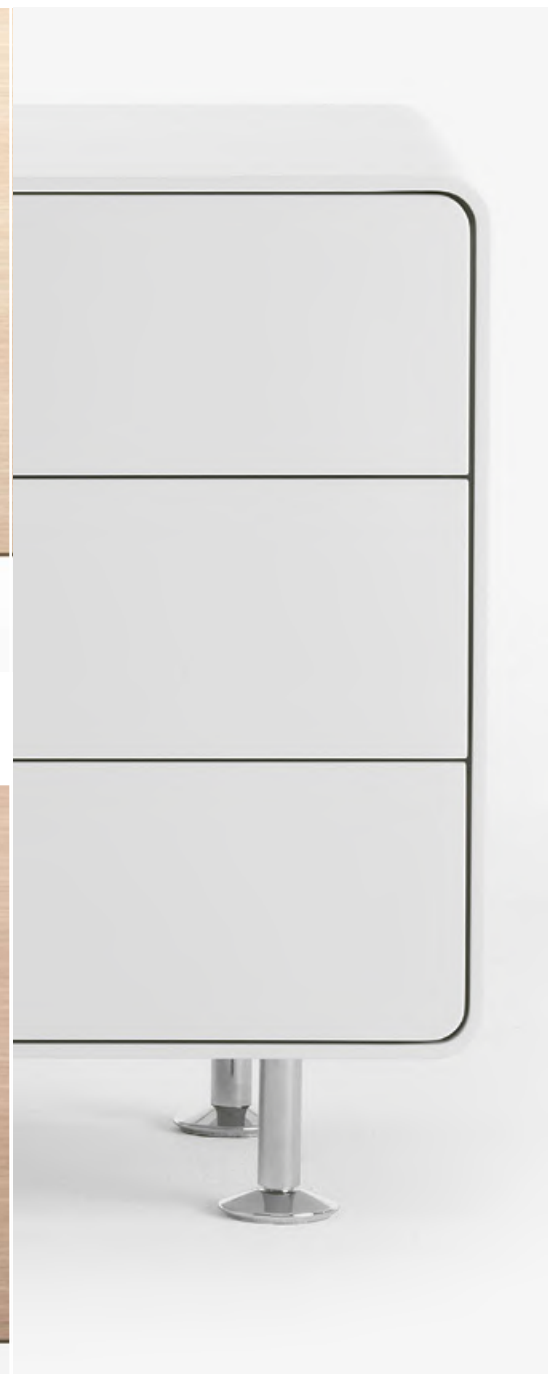

Sideboard mit gerundeten Ecken  
Sideboard with rounded corners





**Schreibtische / Konferenztische**

Desks / Conference tables

18

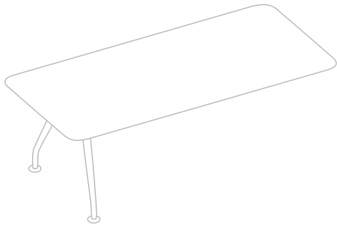

S84/6

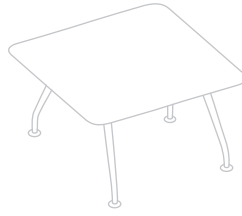

18/4

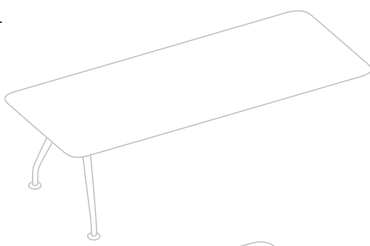

S84/4

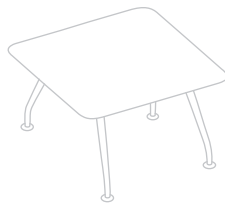

82

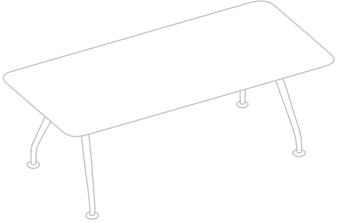

S84/R4

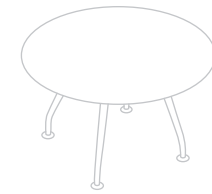

82/4

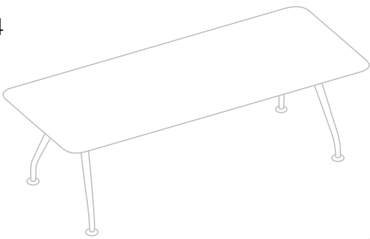

S83/3

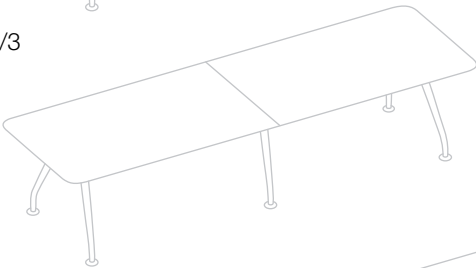

S83/4

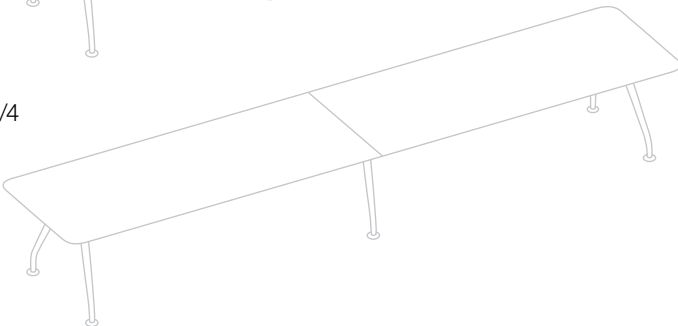

**Container**

Containers

C82



C84



**Sideboarde**

Sideboards

802

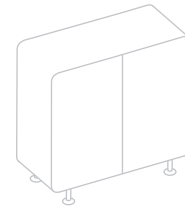

803

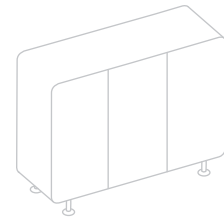

804

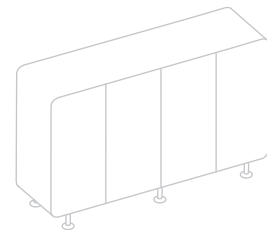

**Sideboarde / Technikcontainer**

Sideboards / Media containers

820

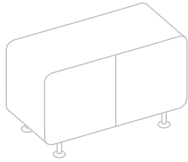

830L

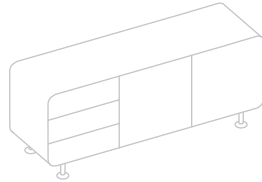

823

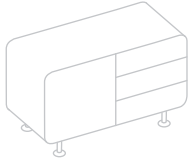

840

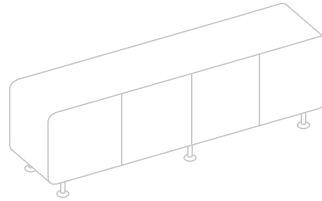

832



840L2

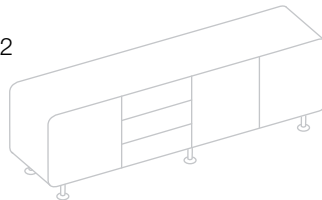

830

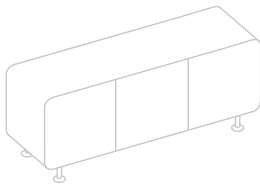

840R1

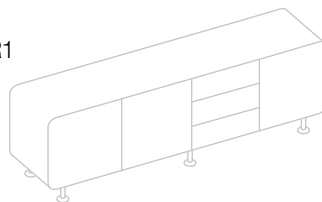

830M

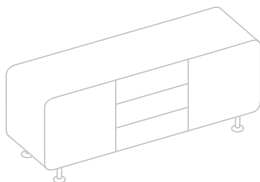

840L1

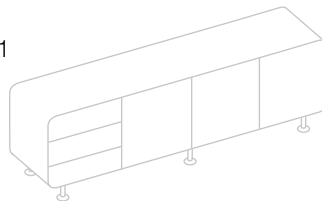

830R

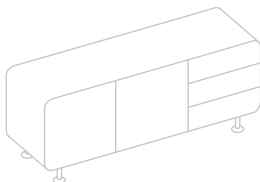

840R2

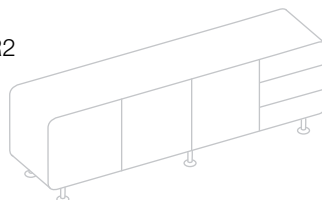

**Hängeboarde**

Suspension boards

SH150

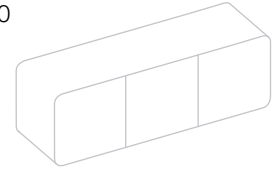

SH200

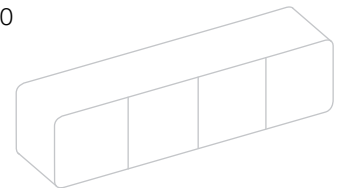

SH240

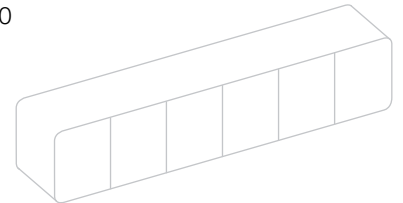

SH240S

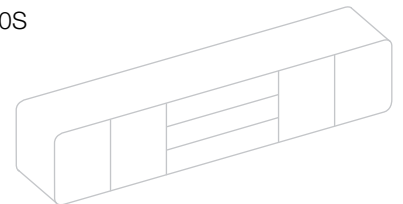

820 100x46x62cm 823 100x46x62cm 832 100x46x62cm 830 150x46x62cm 830M 150x46x62cm 830R 150x46x62cm  
830L 150x46x62cm 840 200x46x62cm 840L2 200x46x62cm 840R1 200x46x62cm 840L1 200x46x62cm 840R2 200x46x62cm  
SH150 150x40x50cm SH200 200x40x50cm SH240 240x40x50cm SH240S 240x40x50cm

Die Abbildungen zeigen einen Auszug aus unserer Produktpalette. Sprechen Sie gerne mit uns über Ihre individuellen Wünsche.  
The images show a sample of our product range. Please talk to us to discuss your individual wishes.



Paintings: Christian Hein



.sun  
Oberfläche Tischplatte: Glas  
Surface tabletop: glass



.qu2 900



Dezent erzeugt sun ein positives Gefühl in jedem Raum. Dazu nimmt das Material die Umgebung auf, sich selbst aber zurück. So entsteht eine Atmosphäre, die für einen freien Kopf sorgt. Dank der Materialeigenschaften von Glas und Chrom erstrahlt sun dabei im besten Licht.

.sun generates a positive feeling in every room. For this, the material takes on the environment, and also itself back. This creates an atmosphere that ensures a clear head. Thanks to the material properties of glass and chrome, sun shines here in the best light.



Ein massiver Sockel, ein starkes Fundament, und darauf ein sich erhebender Körper von majestätischer Ruhe und Ausgewogenheit. Er ist der natürliche Mittelpunkt seiner Umgebung, eine Landmarke, die für Zuverlässigkeit und Permanenz steht. **Das sind taros und taros xl.**

Mit diesem Chefzimmer-System sprechen Sie klare Worte, gestützt durch eine repräsentative Formierung tragender Elemente. Kein Pathos, keine Schnörkel, sondern eine ebenso pragmatische wie selbstbewusste Geisteshaltung zeichnen taros und seinen größeren Bruder taros xl aus.

**Entdecken Sie ein vielseitiges System mit einer deutlichen Botschaft!**

A massive base, a strong foundation, and thereon an uplifting body of majestic calm and balance. It is the natural centre of its surroundings, a landmark, which stands for reliability and durability. **This is taros and taros xl.**

This executive's room system speaks clear words, supported by a representative formation of the bearing elements. No pathos, no frills, but a pragmatic and confident mindset distinguish taros and its bigger brother taros xl.

**Discover a versatile system with a clear message!**



# .taros xl

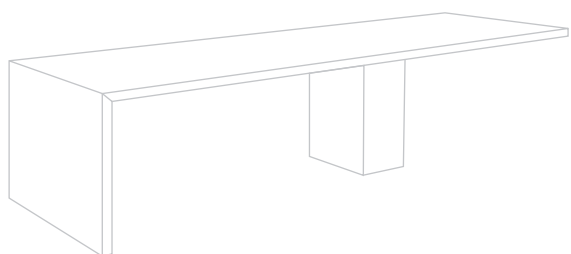

# .taros

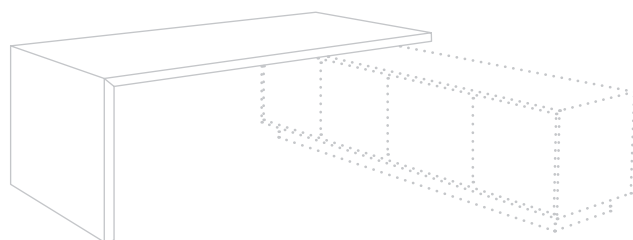

## .taros



Das Chefzimmer der Extraklasse. Mit ausgesuchten Edelhölzern, kombiniert mit Aluminium und hochwertigem Leder, erschafft es ein Gefühl der Sicherheit. Mit seiner Präsenz steht es für Glaubwürdigkeit und Vertrauen. Dies wird vor allem durch seinen funktionalen Umfang demonstriert.

The executive's room is a class of its own. With selected precious woods combined with aluminium and high-quality leather, it creates a sense of security. Its presence here radiates credibility and trust. This is demonstrated in particular by its functional scope.

## .taros xl



Die Serie wurde als Erweiterung des erfolgreichen Managementprogramms taros entwickelt. In seiner vollen Länge lässt dieser majestätische Schreibtisch viel Spielraum zur konstruktiven Entfaltung. Bei 3 – 4 m Länge zeigt er seine Präsenz im Raum.

The series was developed as an extension of the successful management program taros. In its full length, this majestic desk provides plenty of scope for constructive development. At 3 – 4 m in length, it shows its presence in the room.



Schiebepatte mit integrierter Technik (geöffnet)  
Sliding panel with integrated engineering (open)



Schiebepatte (geschlossen)  
Slide plate (closed)



Ledereinlage  
Leather inlay



Tischplatte, optional mit Aluminiumkanten  
Tabletop, optionally with aluminium edges





Klappe im Furnierverlauf (geöffnet)  
Flap in veneer direction (open)

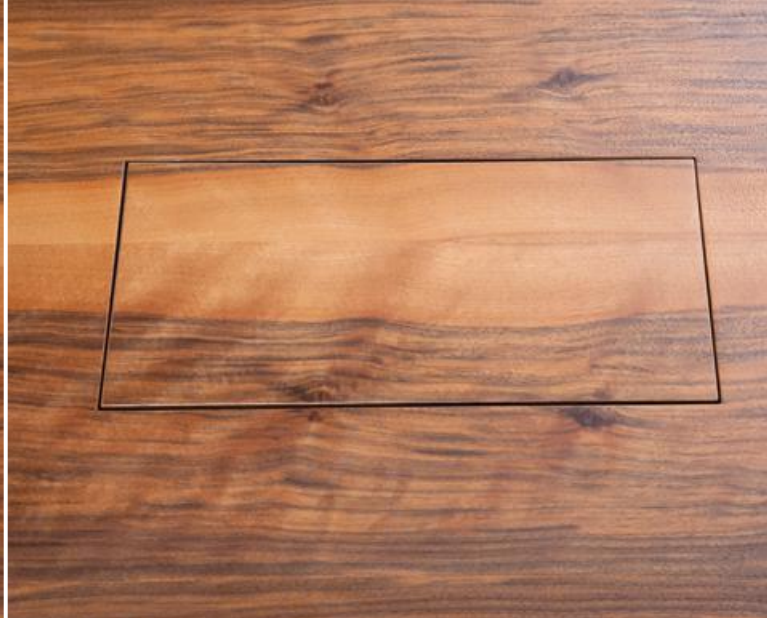

Klappe im Furnierverlauf (geschlossen)  
Flap in veneer direction (closed)



Einglassene Glaseinlage (unterlackiert)  
Recessed glass insert (under painted)



Optische Trennung zwischen Arbeitsfläche und Besprechungssituation  
Optical separation between work space and meeting space





.taros Sideboard mit Aluminum Rahmen  
.taros sideboard with aluminum frame



.taros  
Oberfläche Tineo gebeizt  
Surface tabletop: Stained tineo



.qu2 900







**Schreibtische****Desks**

411

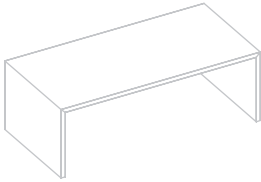

411/4

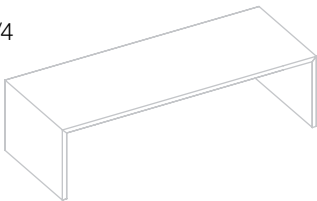

401

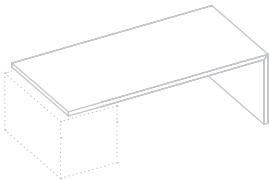

401/4

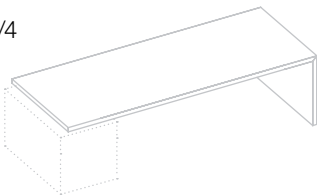

410

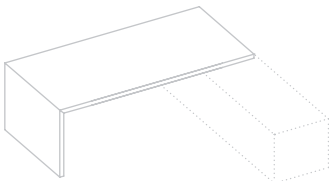

4101/4

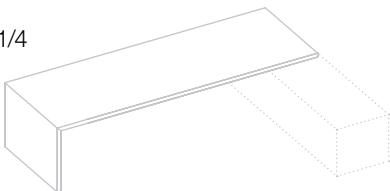
**Container****Containers**

44S

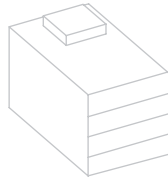
**Sideboarde****Sideboarde**

4200

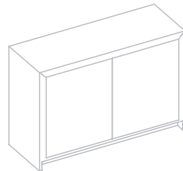

4300

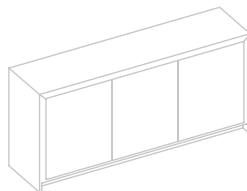

4400

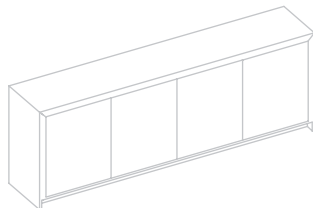
**Technik - Sideboarde****Media Sideboarde**

430T

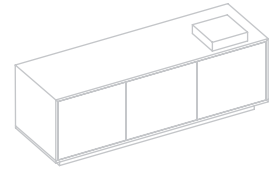

430S

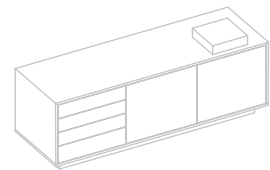

440T

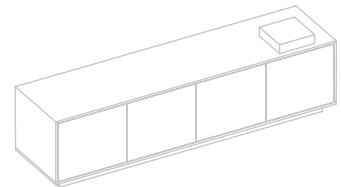

440S

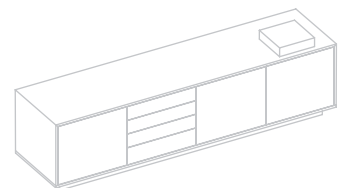

440S/H

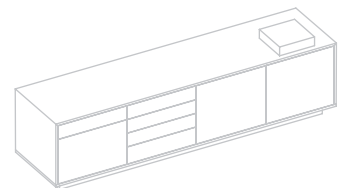

411 215x105x74 cm 411/4 240x105x74 cm 401 215x105x74 cm 401/4 240x105x74 cm 410 215x105x74 cm 410/4 240x105x74 cm

44S 62x105x62 cm 4200 126x46x88 cm 4300 183x46x88 cm 4400 240x46x88 cm

430T 182x60x62 cm 430S 182x60x62 cm 440T 242x60x62 cm 440S 242x60x62 cm 440S/H 242x60x62 cm

Die Abbildungen zeigen einen Auszug aus unserer Produktpalette. Sprechen Sie gerne mit uns über Ihre individuellen Wünsche.  
The images show a sample of our product range. Please talk to us to discuss your individual wishes.



## Schreibtische

### Desks

413R

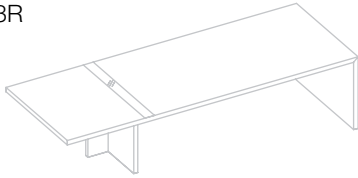

413R

+4L

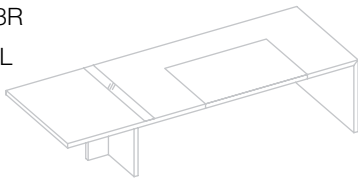

413R

+KTM

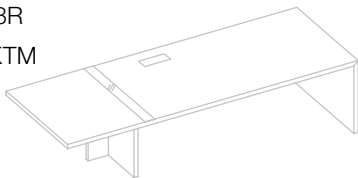

413R

+KI-M

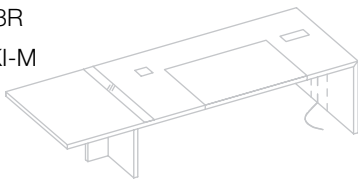

413R

+SP-T

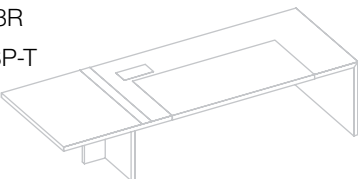

## Container

### Containers

44S



## Sideboarde

### Sideboards

430T

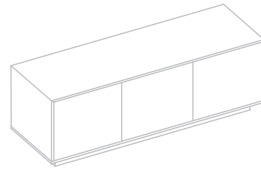

430S

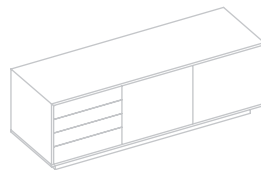

440T

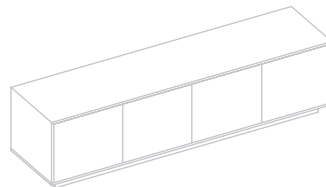

440S

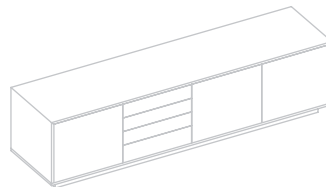

440S/H

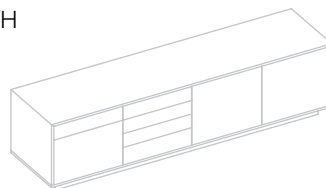

## Sideboarde

### Sideboards

4200

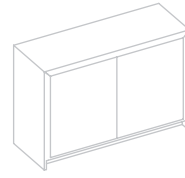

4300

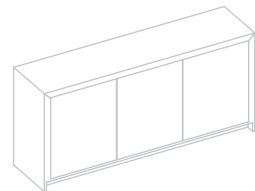

4400

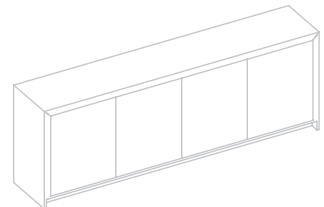

## Ansatzische

### Annexed tables



E140

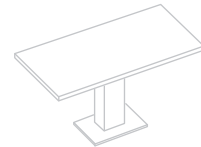

E160

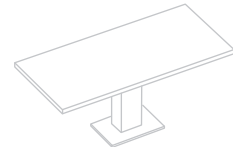

413R 300x110 + 80x110cm (Besucherteil)

44S 62x105x62cm 430T 182x60x62cm 430S 182x60x62cm 440T 242x60x62cm 440S 242x60x62cm 440S/H 242x60x62cm

4200 126x46x88cm 4300 183x46x88cm 4400 240x46x88cm E140 140x70cm E160 160x75cm

Die Abbildungen zeigen einen Auszug aus unserer Produktpalette. Sprechen Sie gerne mit uns über Ihre individuellen Wünsche.  
The images show a sample of our product range. Please talk to us to discuss your individual wishes.



Bestuhlung: tano 020, tano 0202

Ausgezeichnet durch reddot Design-Zentrum Nordrhein-Westfalen: „best selection; office design“

Seating: tano 020, tano 0202

Distinguished by reddot Design Centre North Rhine-Westphalia: „best selection; office design“





Spezialanfertigung: taros mit lackierter Stützwanne und Seitentisch mit Höhenverstellung.

Specific creation: taros with lacquered side support and side table with height adjustment.



# .flair

So kompromisslos wie symbolhaft: Der schwarze Monolith steht für Weiterentwicklung, die Evolution des Daseins. So sah es schon der Autor Arthur C. Clarke in seinem von Stanley Kubrick verfilmten Meisterwerk „2001: A Space Odyssey“, in dem letztlich die mysteriöse geometrische Figur die Verwandlung des Menschen initiiert. Eine solche Transformation gelingt auch mit flair.

Die geometrisch angeordneten Platten schieben sich hier zu einem harmonischen Kollektiv zusammen. Als Schreibtisch-Set zeigt flair eine moderne Haltung mit Sachlichkeit und purer, bestimmter Klarheit. Die weich anmutende Oberfläche verleiht hingegen für ein angenehmes Gefühl.

**Verschieben Sie die Grenzen des  
Gewöhnlichen – mit der Klarheit dieses  
Chefzimmers.**

As uncompromising as symbolic: this black existence. Already author Arthur C. Clarke in his masterpiece as filmed by Stanley Kubrick „2001: A Space Odyssey“, in which ultimately the mysterious geometric figure initiates the transformation of man. Such a transformation is also possible with flair.

The geometrically arranged plates lead here to a harmonious collective. As Desk set, flair shows a modern approach with objectivity and a pure, certain clarity. The soft-looking surface gives contrast for a pleasant feeling.

**Move the limits of the ordinary –  
with a clarity of this executive's office.**

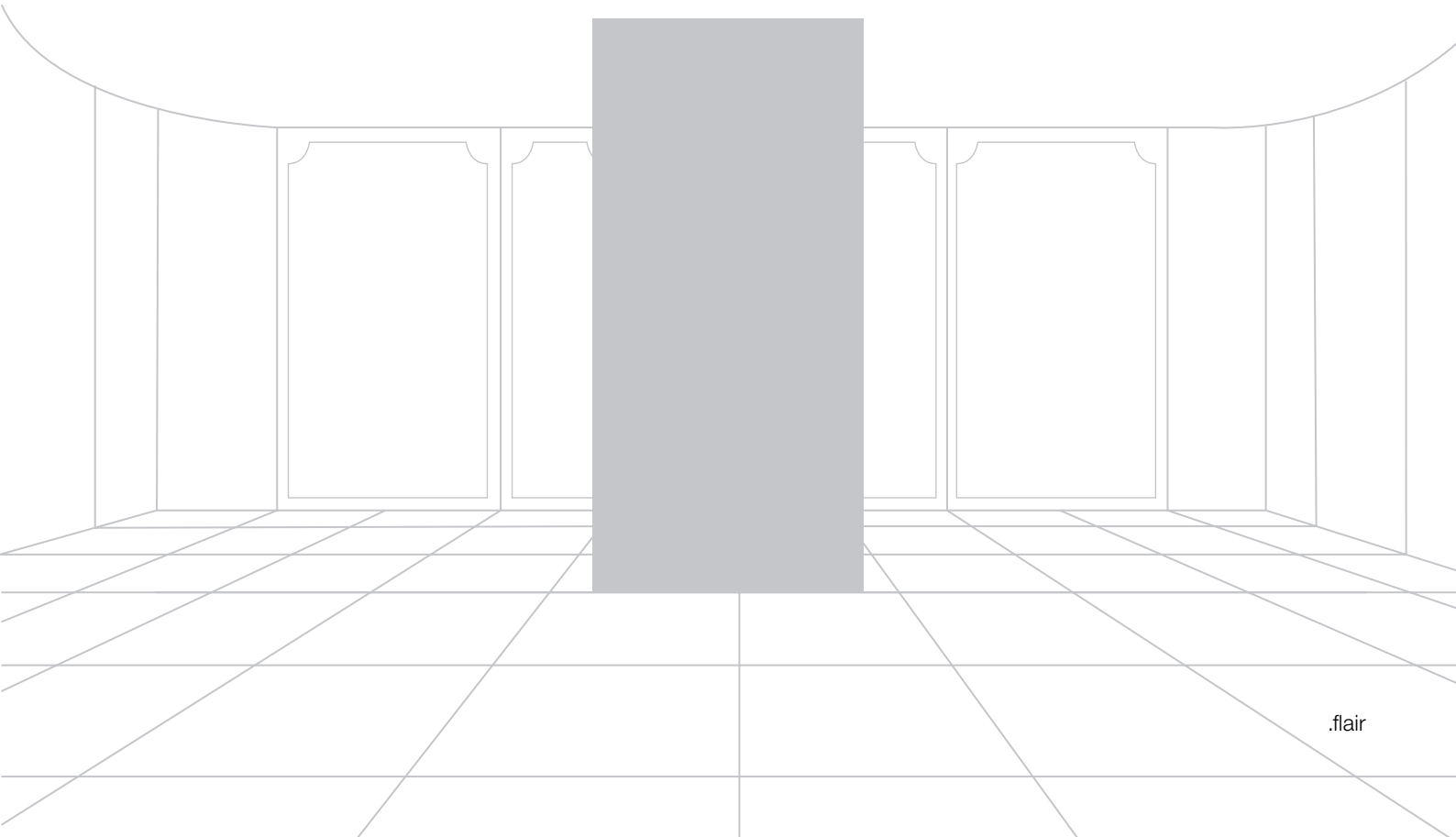





### **Soft Touch**

Die Oberfläche erzielt durch die neuen Materialien, wie zum Beispiel NanoTec, eine weiche Soft-Touch-Haptik. Die ausstrahlende Wärme macht jede Berührung zu einem Erlebnis. Das Material ist in mehreren Farben wählbar. Die Lichtwirkung bringt Ruhe in jeden Raum und verschafft eine optimale Atmosphäre.

The surface is created by new materials, such as NanoTec, and gives a comfortable soft touch feel. The heat radiating makes any contact an experience. The material can be selected in several colours. The light effect brings peace in every room and provides an optimal atmosphere.





Frei hängende Unterschränke  
Free hanging base cabinets



Kabelzufuhr aufgeklippt  
Clipped wire feed

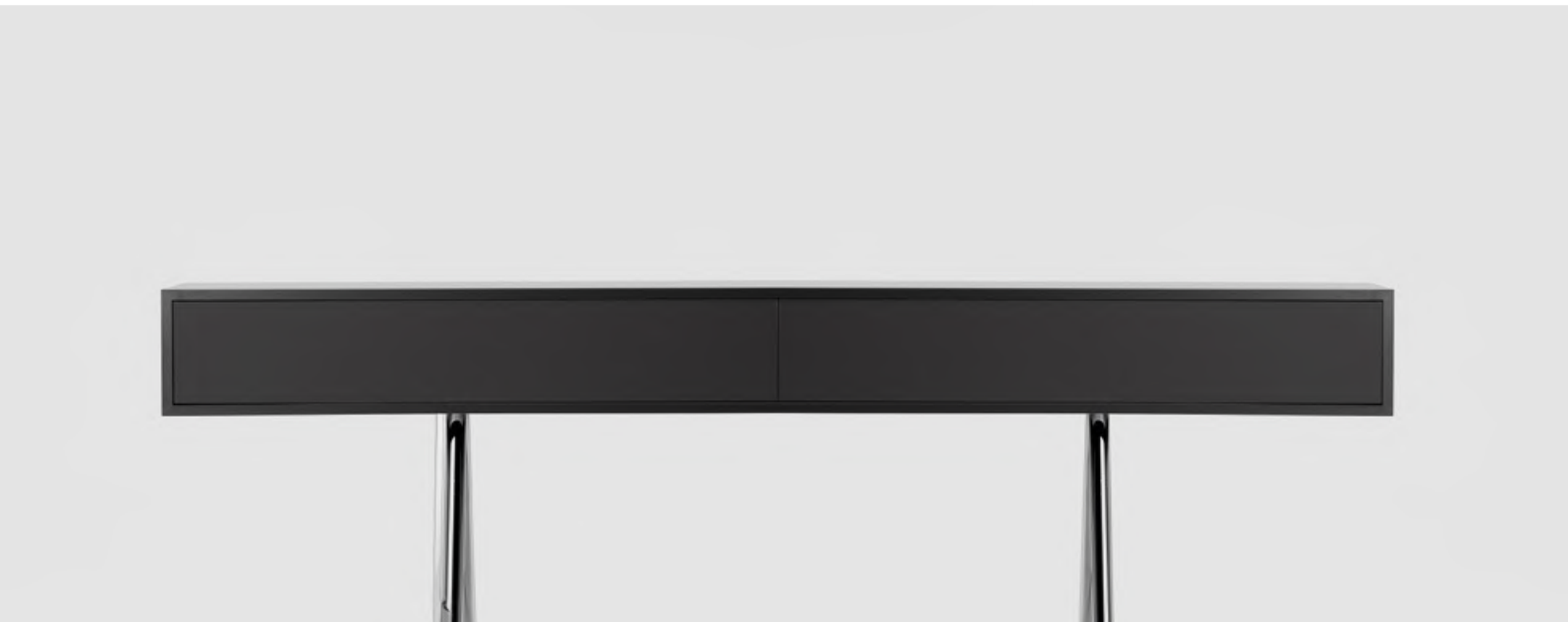

Schubladen-Sideboard in verschiedenen Größen  
Drawer sideboard in different sizes



Fußgestell aus verchromtem Stahlrohr  
Base in chromed steel tube



Seitenansicht mit Drehsessel tallis  
Side view with swivel armchair tallis





**Schreibtische**

**Desks**

Z44/8

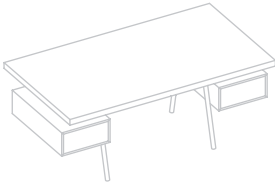

Z44/1

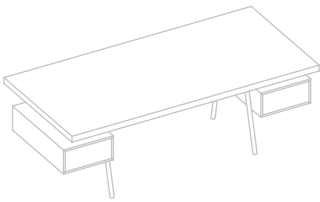

Z44/4

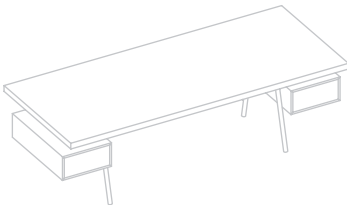

**Sideboarde**

**Sideboards**

Z36/2



Z36/3L



Z36/3R



Z36/3



Z36/4L



Z36/4M



Z36/4R



**Schubladenboarde**

**Drawer boards**

Z2/15

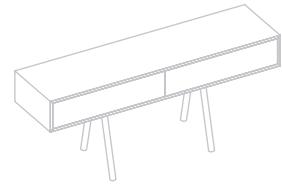

Z2/20

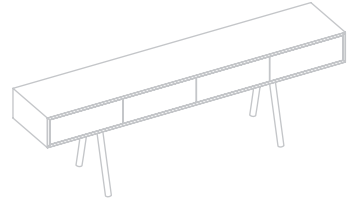

Z44/8 180x90x74 cm Z44/1 210x100x74 cm Z44/4 240x100x74 cm  
 Z36/2 100x40x74 cm Z36/3L 100x40x74 cm Z36/3R 100x40x74 cm Z36/3 150x40x74 cm Z36/4L 150x40x74 cm Z36/4M 150x40x74 cm Z36/4R 150x40x74 cm  
 Z2/15 150x40x65 cm Z2/20 200x40x65 cm

Die Abbildungen zeigen einen Auszug aus unserer Produktpalette. Sprechen Sie gerne mit uns über Ihre individuellen Wünsche.  
 The images show a sample of our product range. Please talk to us to discuss your individual wishes.





**.flair Schreibtisch mit Sideboard**

Oberfläche NanoTec, softmatt schwarz, 2 Container-Schubladen

**.flair desk with sideboard**

Surface NanoTec, soft matt black, 2 container drawers



.tallis 600





Klare Aussichten

Clear views



## Komfortable Wartebereiche. Comfortable waiting areas.



Materialvielfalt zur individuellen Gestaltung.

Material diversity for individual expression.





Code scannen und mehr über  
unsere Besucherguppen erfahren.

Scan the code and learn more  
about our visitor groups.





# .safe

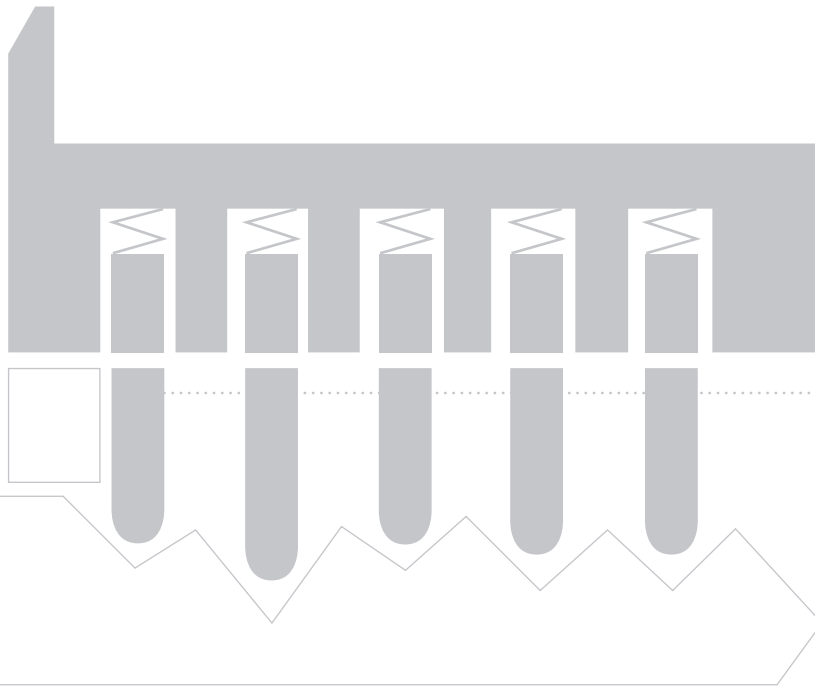

Mit äußerster Genauigkeit schiebt sich der Kern in eine umgreifende Form und bildet ein individuelles Profil, passgenau ausgerichtet mit speziell definierten Kerben. Dank dieser mechanischen Codierung wird das Ensemble zu einer geschützten Einheit. Das ist Präzision. Das ist safe.

Soviel ist sicher: safe bietet Ihnen einen Zugang zu einer ebenso komfortablen wie funktionalen Arbeitsumgebung. Seine verschiedenen Anordnungen ergeben vielfältige Möglichkeiten zur ganz persönlichen Arbeitsplatzeinrichtung und auch die funktionalen Highlights lassen diesen Tisch zu einem Alleskönner werden.

With extreme precision, the core pushes in a wrap-around shape and forms an individual profile, precisely aligned with specially defined notches. Thanks to this mechanical coding, the ensemble is an armoured unit. That's precision. This is safe.

This much is certain: safe offers access to a comfortable yet functional work environment. Its various configurations offer many options for the personal workstation device and its functional highlights make this table an all-rounder.









Flexibler Stauraum entsteht  
durch ein frei wählbares Raster.

Flexible storage space is formed  
by a freely selectable grid.



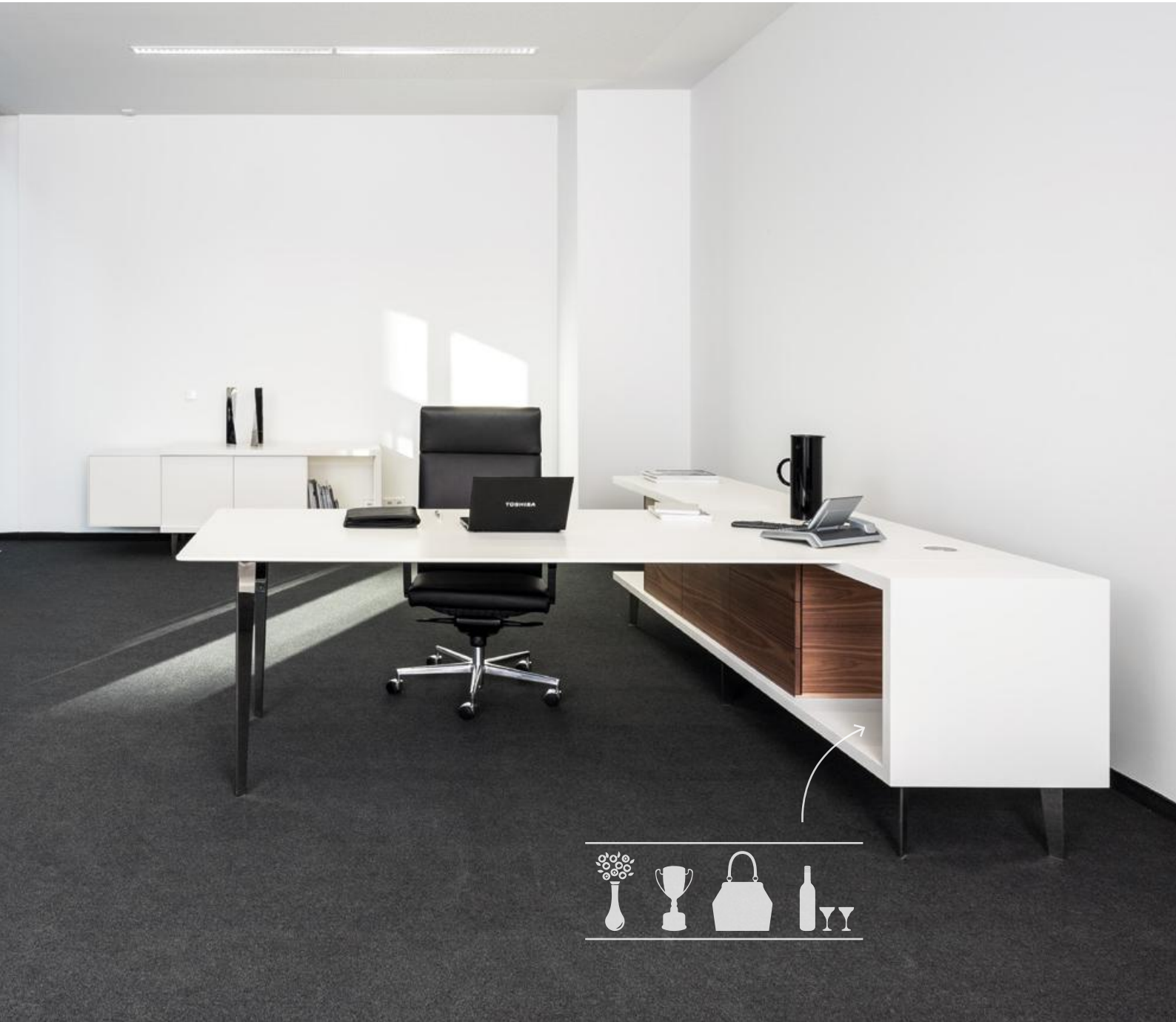

## Flexibilität für jeden Typ. Flexibility for each type.

Das Raster des Sideboards sowie des Containers erlaubt drei verschiedene voreinstellbare Stufen. Hier entsteht Raum für Ablage und Dekoration.

The grid of the sideboards and the container allow three different pre-settable stages. Here you create space for storage and decoration.





FüÙe aus Edelstahl, poliert  
Feet in stainless steel, polished



Drehbarer Kabelausslass  
Swivel cable outlet



Sideboard mit höhenverstellbarer Arbeitsplatte  
Sideboard with height-adjustable work surface



Integrierter Taster zur elektromotorischen Höhenverstellung  
Integrated pushbutton for powered height adjustment

1.



2.



3.





**Schreibtische**

**Desks**

T15L



T15R



T40L



T40R



**Sideboardspangen**

**Sideboard clasps**

S15

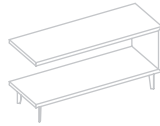

S17

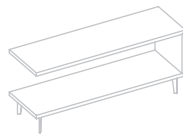

S20



S22

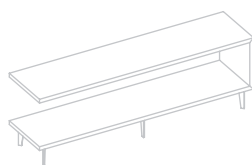

S25

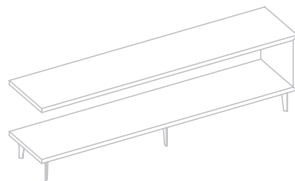

**Sideboardschränke**

**Sideboard cabinets**

K11

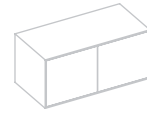

K12

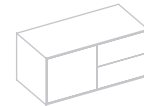

K111

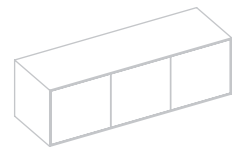

K112

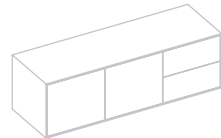

K121

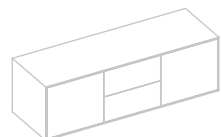

K211

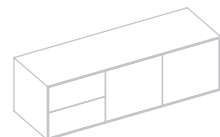

### Highboardspangen

Highboard clasps

S10/2



S15/2



S17/2

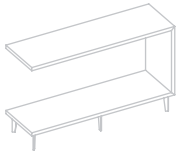

S20/2

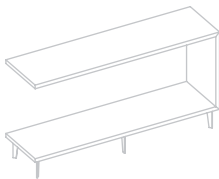

### Highboardschränke

Highboard cabinets

K10/2

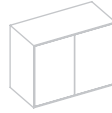

K15/2

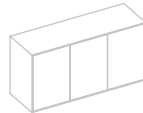

### Hängeboarde

Suspension board

H150

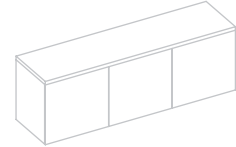

H200

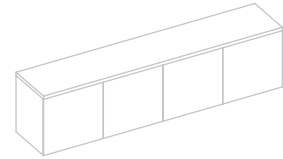

H240

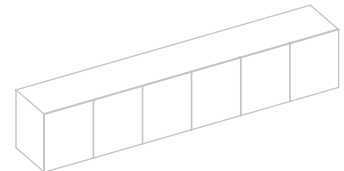

H240S

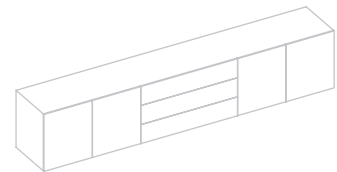

### Höhenverstellung

Height adjustment



SE

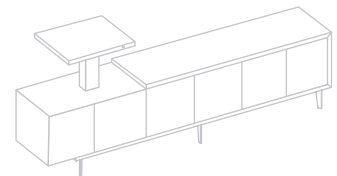

**S10/2** 100x55x105 cm **S15/2** 150x55x105 cm **S17/2** 175x55x105 cm **S20/2** 200x55x75 cm

**K10/2** 100x50x76 cm **K15/2** 150x50x76 cm

**H150** 150x40x50 cm **H200** 200x40x50 cm **H240** 240x40x50 cm **H240S** 240x40x50 cm

Die Abbildungen zeigen einen Auszug aus unserer Produktpalette. Sprechen Sie gerne mit uns über Ihre individuellen Wünsche.  
The images show a sample of our product range. Please talk to us to discuss your individual wishes.









# .con air

Suchte man ein einzelnes Utensil als Symbol für die neue, globalisierte Arbeitswelt, ein Sinnbild für beiläufiges Weltbürgertum – es wäre der Rollkoffer. Nichts verkörpert besser die routinierte Mobilität, als der Start des Geschäftsreisenden vom Gepäckband in Richtung Ausgang. Mühelos, unaufgeregt, binnen Sekunden in einer neuen Welt angekommen. Willkommen bei con air.

Dieses Chefzimmersystem ist der Inbegriff der Mobilität innerhalb des Raumes. Es eröffnet die Möglichkeit, sowohl im Sitzen als auch im Stehen zu arbeiten – und das gemäß höchsten Ansprüchen an Komfort und Ergonomie. Der stufenlos höhenverstellbare Schreibtisch erhöht Dynamik und Lebensqualität, mit intuitiver Bedienbarkeit und exklusivem Design.

**Bringen Sie Ihre Ideen stufenlos auf ein noch höheres Level.**

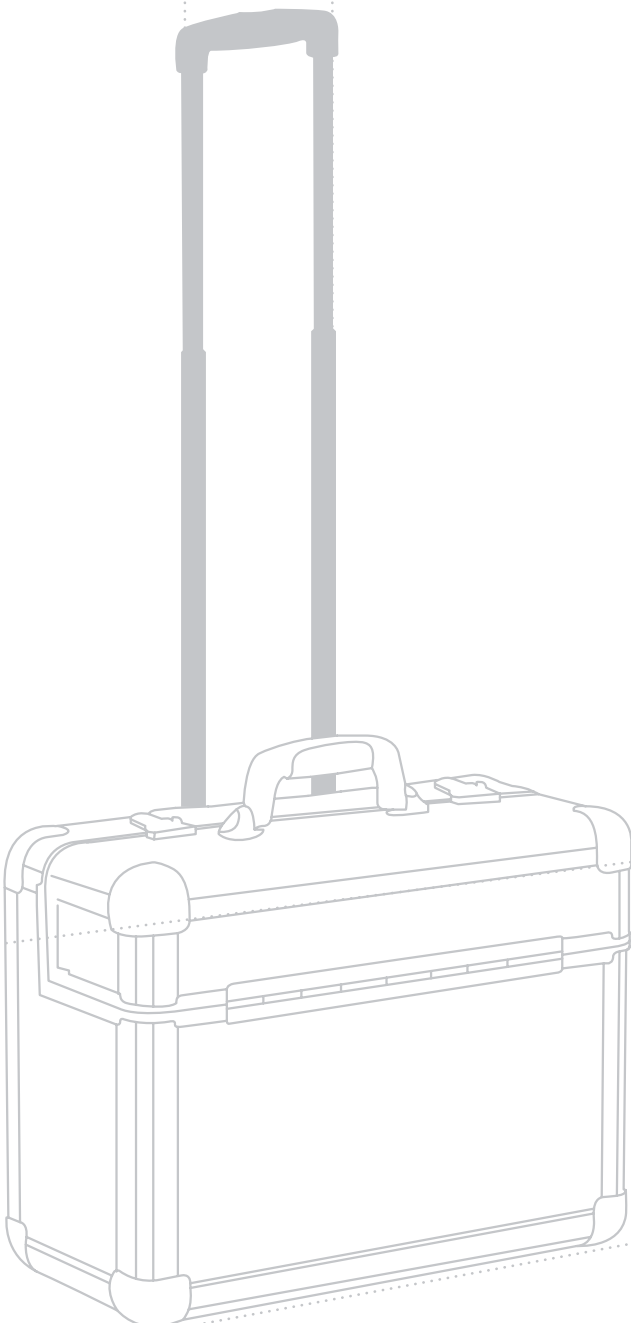



If one seeks a single tool symbolising the new globalised world of work, a symbol of casual cosmopolitanism – then you reach the rolling suitcase. Nothing embodies better the experienced mobility, as the start of business travellers from the baggage carousel towards the exit. Effortless, unexcited, you arrive within seconds in a new world. Welcome to con air.

This executive's office system is the epitome of mobility within the room. It opens the possibility of working both sitting and in a standing position – and according to the highest standards of comfort and ergonomics. The steplessly adjustable desk increases dynamism and quality of life, with easy handling and an exclusive design.

**Bring your ideas continuously to an even higher level.**



Unsichtbare Kabelführung  
Concealed cable management



Integrierter Taster zur Höhenverstellung  
Integrated button for height adjustment



Lederauflage mit Abkantung  
Leather cover with fold



Ausziehbare Ledereinlage mit integrierter Technik und Materialmulde  
Extendable leather insert with integrated multimedia and material tray

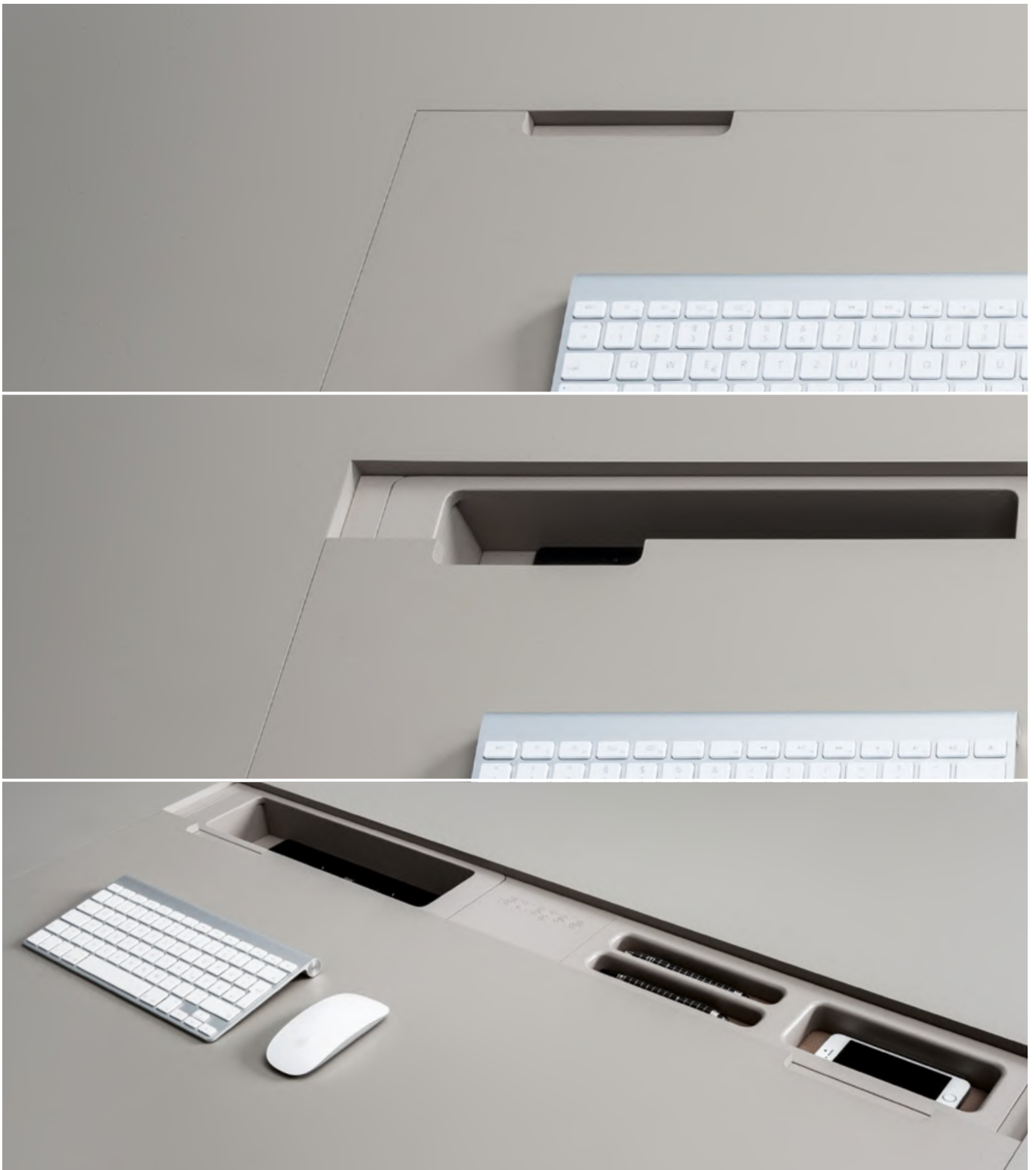

Ausziehbare Einlage, materialgleich mit Tischplatte (Abb. in NanoTec)  
Extractable insert, the same material with top (fig. in NanoTec)



# Dynamische Blickwinkel

## Dynamic viewpoint

Konferenzlösungen mit Höhenverstellung: 74 – 118 cm  
Conferencing solutions with height adjustment: 74 – 118 cm



Durch die elektromotorische Höhenverstellung ergeben sich nicht nur Optionen der Körperhaltung, sondern auch ganz neue interaktive Aspekte der Nutzung im Raum. Das Wachsen verändert den Fluss von Informationen und sorgt für einen neuen Standpunkt. Eine Änderung der Tischhöhe bietet Übersicht, Dynamik und lädt automatisch zu mehr Geselligkeit ein.

By motorized height adjustment you not only obtain posture options, but also completely new interactive aspects of the use in space. The increase changes the flow of information and establishes a new position. A change of table height gives overview, dynamics and automatically leads to more socializing.

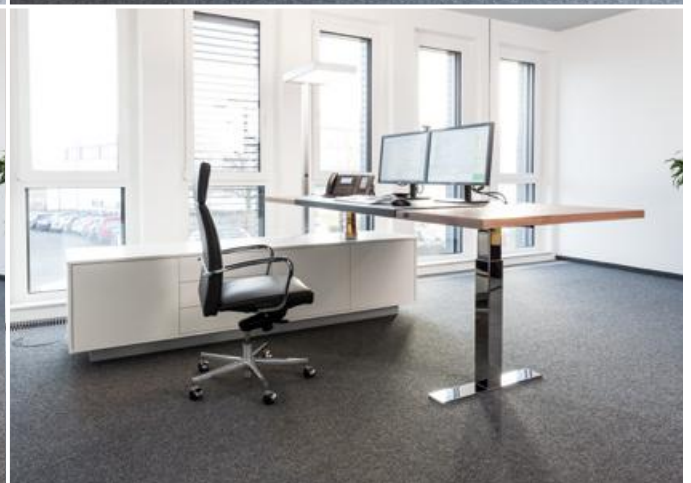
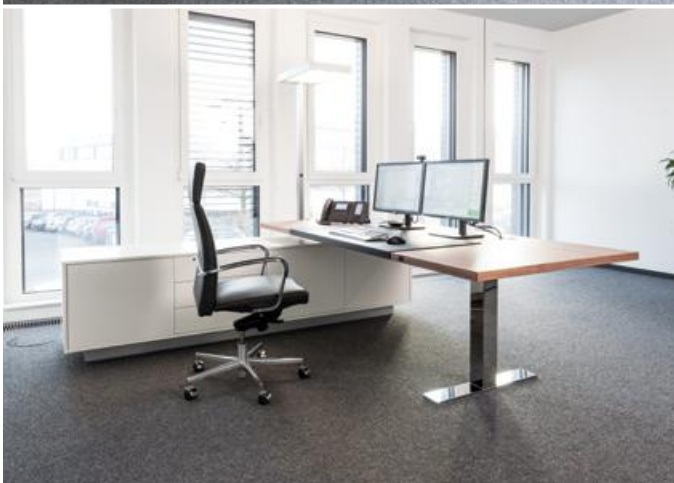
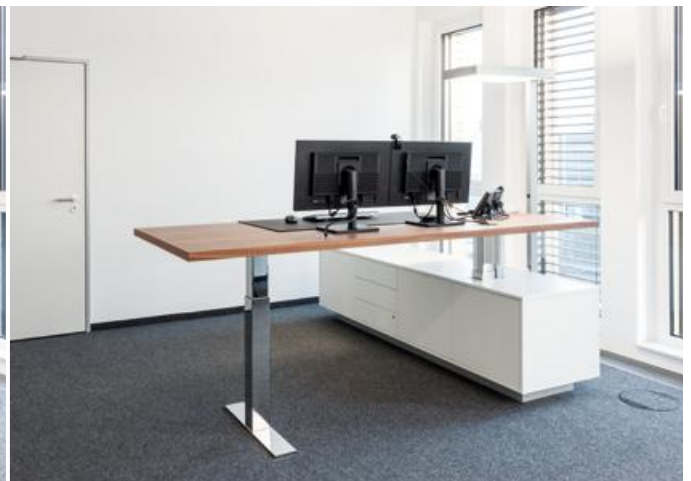
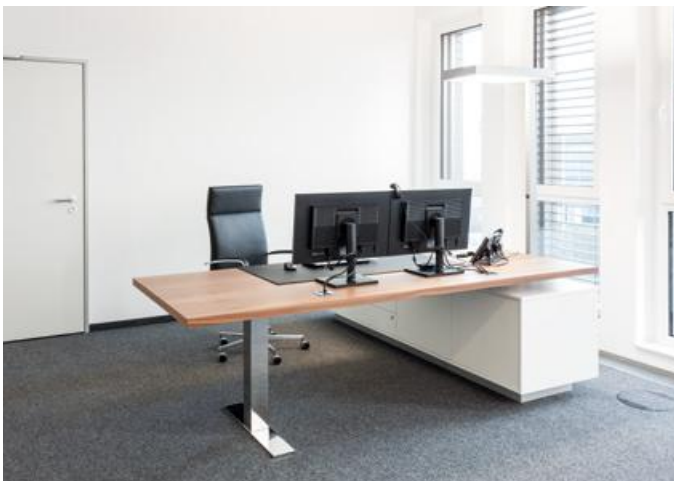









**Schreibtische**

**Desks**

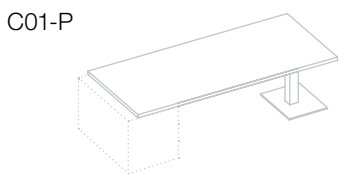
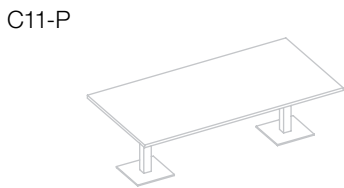
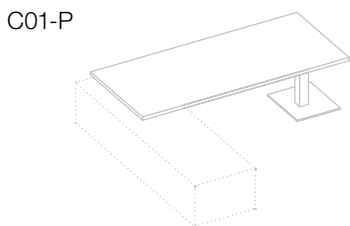
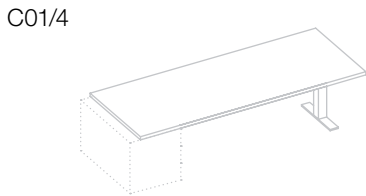
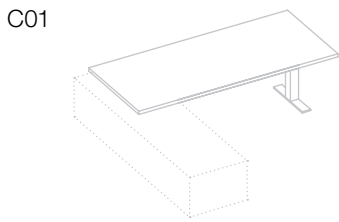
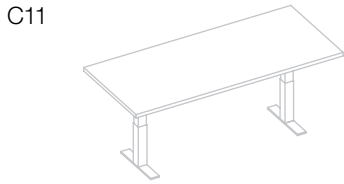

**Container**

**Containers**

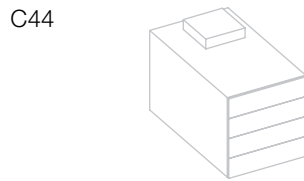
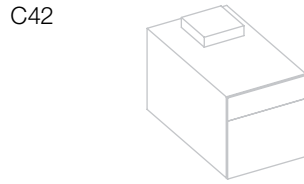

**Technik-Sideboarde**  
**Multimedia sideboards**

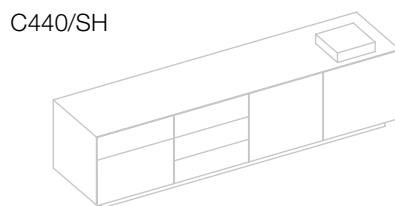
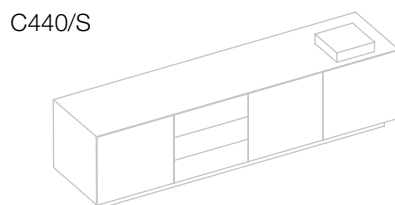
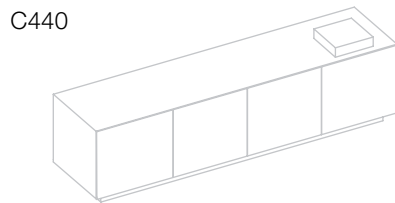
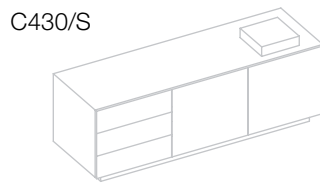

**Sideboarde**

**Sideboards**

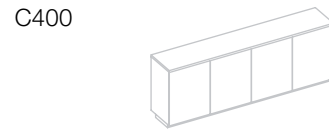
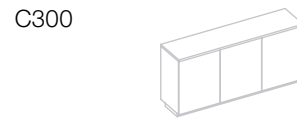

**Hängeboarde**

**Suspension boards**

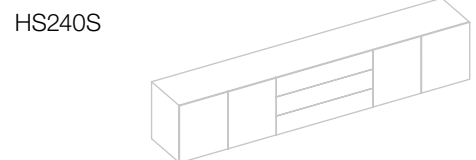
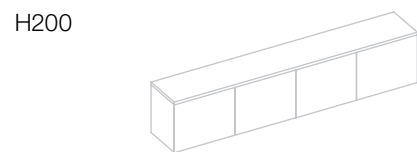
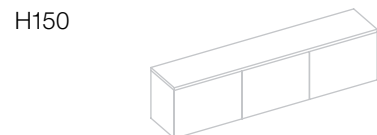

**C11** 215 x 105 x 74 cm **C01** 215 x 105 x 74 cm **C01/4** 240 x 105 x 74 cm **C01-P** 215 x 105 x 74 cm **C11-P** 215 x 105 x 74 cm **C01-P** 215 x 105 x 74 cm  
**C42** 60 x 105 x 62 cm **C44** 60 x 105 x 62 cm **C430/S** 182 x 60 x 62 cm **C440** 242 x 60 x 62 cm **C440/S** 242 x 60 x 62 cm **C440/SH** 242 x 60 x 62 cm  
**C200** 120 x 46 x 88 cm **C300** 180 x 46 x 88 cm **C400** 240 x 46 x 88 cm **H150** 150 x 40 x 50 cm **H200** 200 x 40 x 50 cm **HS240S** 240 x 40 x 50 cm

Die Abbildungen zeigen einen Auszug aus unserer Produktpalette. Sprechen Sie gerne mit uns über Ihre individuellen Wünsche.  
 The images show a sample of our product range. Please talk to us to discuss your individual wishes.



**.con air** Tischplatte mit Lederauflage und Sideboard; Oberfläche: Strukturlack.  
Elektromotorische Höhenverstellung durch integrierten Taster in der vorderen Plattenkante.  
Bei Ausführung mit Höhenverstellung ist das Stromkabel im Fuß integriert,  
zusätzlich zwei Anschlüsse 230V im Kabelkanal.

**.con air** table with leather finish and sideboard; surface: textured paint.  
Electromotive height adjustment by a dedicated button in the front panel edge.  
For models with height adjustment, the power cable is integrated in the base,  
in addition two 230V connections in the cable channel.



.pilot P200

# Furniere\* Veneer



Leder  
Leather



Strukturlack  
Textured paint



NanoTec  
NanoTec



\* Alle Farben stellen lediglich einen Auszug aus unserer Farbpalette dar. Die abgebildeten Farben sind nicht farbverbindlich.  
All colours are only an extract from our full range of colours. The colours shown are not binding.





## Wir entfesseln Potenziale.

Hochwertige Materialien warten in großer Vielzahl in unserem Lager auf die richtige Gelegenheit. Dazu wählen wir exquisite Furniere sowie Leder höchster Qualität aus. Wann immer möglich, präferieren wir Ressourcen aus der Region und setzen auf zertifizierte Rohstoffe. Diese fügen wir mit qualifizierten Fachleuten in unserem Werk in Nettetal zusammen. Die Kunst unserer Spezialisten ist es, die richtigen Materialien zu wählen und sie stimmig miteinander zu kombinieren – zu einem typischen spiegels Chefzimmer.





## We unleash the potential.

High quality materials are available in great variety in our warehouse, for the right opportunity. To do this we select exquisite veneers and leather of the highest quality. Whenever possible, we prefer resources from the region and rely on certified raw materials. We combine them at our plant in Nettetal with our qualified professionals. The art of our specialists is in choosing the correct and consistent – a typical spiegels executive office.

## Wir haben eine Heimat

### We have a home

Der Firmensitz von spiegels ist und bleibt Nettetal. Im Herzen des Naturparks Schwalm-Nette produzieren wir alle unsere Möbel – zu 100 Prozent vom Niederrhein und von hier aus in die Welt. Denn hier sind nicht nur wir, sondern auch unsere langjährigen Mitarbeiter verwurzelt, hier finden wir die Ruhe, unsere Talente und unsere Leidenschaft für beste Möbel voll auszuspielen. „Made in Germany“ ist daher für uns keine Floskel, sondern ein täglicher Qualitätsbeweis.

Neben Produktion und Verwaltung gibt es hier natürlich auch unseren Showroom, in dem wir Besuchern gerne Innovationen und unsere größten Klassiker präsentieren. Besuchen Sie uns und erleben Sie die Qualität von First Class Office Manufacturing mit allen Sinnen.

The headquarters of spiegels is and remains Nettetal. In the heart of the nature park Schwalm-Nette, we produce all our furniture - 100 percent from the Lower Rhine and from here into the world. Because here are not only we, but also our long-term employees have theirs, here we find the peace to fully exploit our talents and our passion for best furniture. "Made in Germany" is therefore for us not just a phrase, but a daily quality to be proven.

In addition to production and management, we also have here our showroom, where we like to introduce visitors to innovations and our greatest classics. Visit us and experience the quality of First Class Office Manufacturing with all your senses.



## Qualität und Auszeichnung

### Mark of Quality

Als Spezialisten in der Massivholz- und Furnierverarbeitung verwenden wir zertifizierte Hölzer. Die Zertifikate FSC und PEFC gelten als Indikatoren für eine verantwortungsvolle Waldwirtschaft und weltweite Transparenz.

**In unserem Unternehmen verwenden wir ausschließlich qualitativ hochwertige Materialien. Die Produktion erfolgt zu 100% im Werk in Nettetal.**

As specialists in solid wood and veneer processing we use certified wood. The FSC and PEFC certificates are considered confirmation of a responsible forest management and global transparency.

**In our company we use only high quality materials. Production is 100% in our factory in Nettetal (Germany).**





Spiegels GmbH & Co. KG  
Thalweg 4 . 41334 Nettetal

Fon +49 2153.95 3 96.0  
Fax +49 2153.95 3 96.20  
info@spiegels.de  
www.spiegels.de

© spiegels